

BIO ETHANOL STOVE

This guide is to be used in conjunction with the manual supplied with the stove

*Images for illustrative purposes only

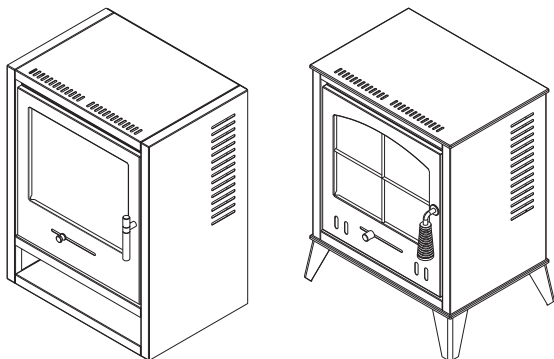

This manual is for the following models:

OKO S1	OKO S2	OKO S3	BEF0014 (S1)	BEF0014 (S2)	BEF0018 (S3)
BEF0019	BEF0020	BEF0021	OKO S1-R	OKO S2-W	OKO S2-D
OKO S4	OKO S5	OKO S6			

Do **NOT** place **ANYTHING** inside the burner chamber, i.e Ceramic Logs/Pebbles etc.

This will affect the air flow inside the chamber and create an unsafe and less controlled flame.

LANGUAGES

English	02-04
Français	05-08
Deutsch	09-12
Italiano	13-16
Español	17-20
Polski	21-24
Română	25-28

Please read through the use & care manual provided with this product first.

www.firedupcorporation.com/manual

DISTANCES FROM WALL

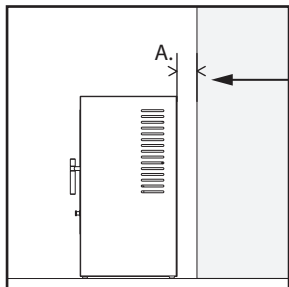

Distance from A.

- Marble/Stone: > 5mm
- Wood (including MDF & MFC): > 10mm
- Wallpaper: > 100mm

OPENING THE DOOR

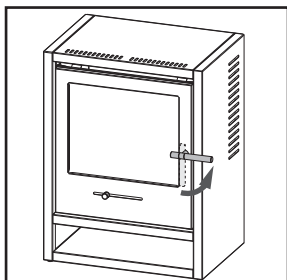

1. To open the door, turn the handle anti-clockwise to a horizontal position.

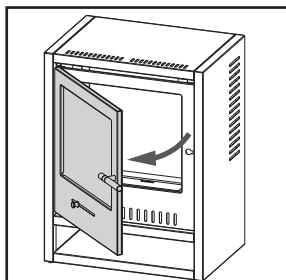

2. Once in position, pull the door to open.

ATTENTION

Do not store fuel on the shelf underneath the fire.

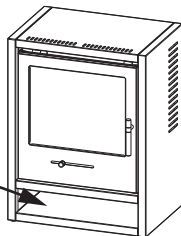

IMPORTANT

FITTING THE STOVE PIPE (if applicable)

ONLY COMPATIBLE WITH ADAM STRAIGHT OR ANGLED STOVE PIPES

Parts Supplied

2 x Metal Plates

*Images for illustrative purposes only

1. Assemble the stove pipe insert into an 'X' and push into the bottom of the stove pipe.

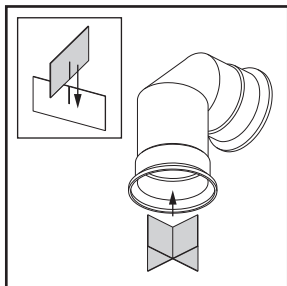

2. Place the stove pipe on top of the stove and push the stove pipe against the wall/back panel.

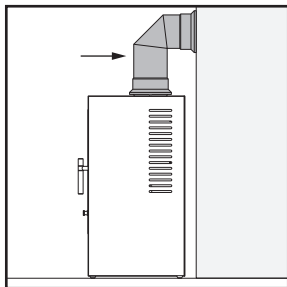

ATTENTION: DO NOT place anything within 50mm of the front of the stove to ensure the vents on top of the stove are left clear.

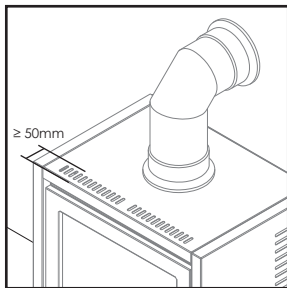

FITTING THE LOG STORE (supplied separately)

*Images for illustrative purposes only

1. **For products with feet only.**
For products without feet, move straight to Step 2.

NOTE: REMOVE THE BURNER BEFORE
 LAYING THE STOVE ON ITS BACK

Lay the stove on its back and remove the
 4 x feet from the stove using a screwdriver.

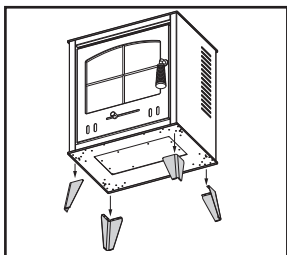

2. Position the log store in the desired place.
 Then, carefully lift the stove and place it onto the log store.

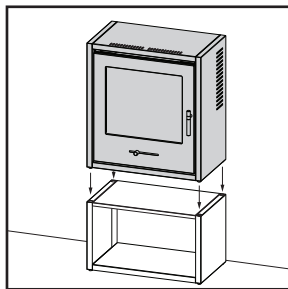
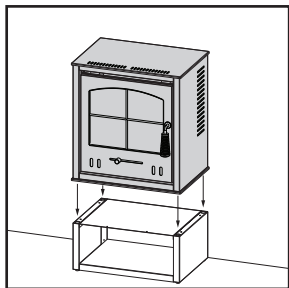
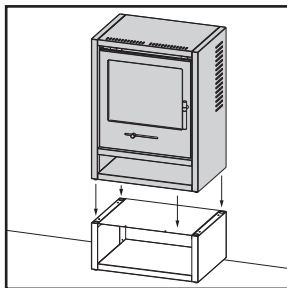

POÊLE À BIOÉTHANOL

Ce guide doit être utilisé en conjonction avec le manuel
fourni avec le poêle

*Image à des fins d'illustration uniquement

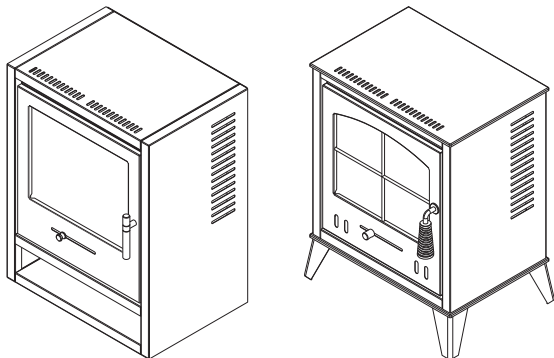

Ce manuel concerne les modèles suivants:

OKO S1	OKO S2	OKO S3	BEF0014 (S1)	BEF0014 (S2)	BEF0018 (S3)
BEF0019	BEF0020	BEF0021	OKO S1-R	OKO S2-W	OKO S2-D
OKO S4	OKO S5	OKO S6			

NE PLACEZ REIN à de la chambre du brûleur, c.-à-d. bûches en céramique/cailloux etc.

Cela affectera le flux d'air à l'intérieur de la chambre et créera une
flamme dangereuse et moins contrôlée.

Veuillez d'abord lire le manuel d'utilisation et d'entretien fourni avec ce produit.

www.firedupcorporation.com/manual

DISTANCES PAR RAPPORT AU MUR

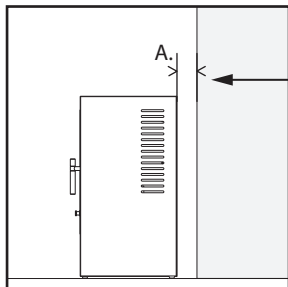

Distance par rapport A

- Marbre/pierre: > 5mm
- Bois (y compris MDF et MFC): > 10mm
- Papier peint: > 100mm

POUR OUVRIR LA PORTE

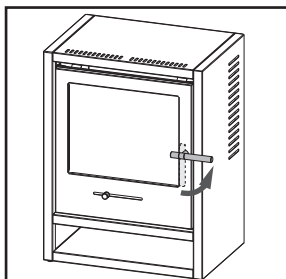

1. Pour ouvrir la porte, tournez la poignée dans le sens inverse des aiguilles d'une montre jusqu'à la position horizontale.

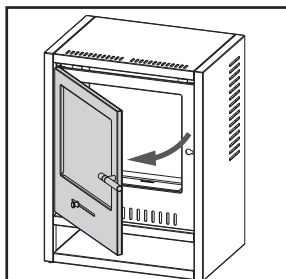

2. Une fois en position, tirez sur la porte pour l'ouvrir.

ATTENTION

Ne pas stocker de carburant sur l'étagère située sous le feu.

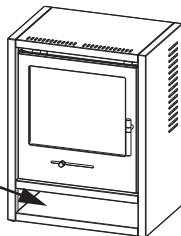

IMPORTANT

MONTAGE DE LA TUYAUTERIE DE LA POÊLE (le cas échéant)

COMPATIBLE UNIQUEMENT AVEC LES TUYAUX DE POÊLE DROITS OU COUDÉS ADAM

Pièces fournies

2 x plaques métalliques

*Image à des fins d'illustration uniquement

1. Assembler l'insert du tuyau de poêle en forme de « X » et l'enfoncer dans le fond du tuyau de poêle.

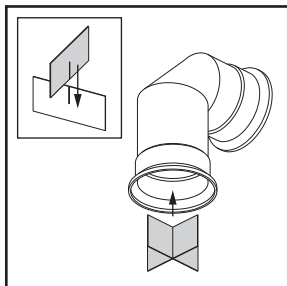

2. Placez le tuyau de poêle sur le dessus du poêle et poussez le tuyau de poêle contre le mur/le panneau arrière.

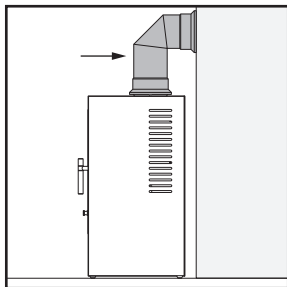

ATTENTION: NE RIEN placer à moins de 50 mm de l'avant du poêle pour que les orifices d'aération situés sur le dessus du poêle soient dégagés.

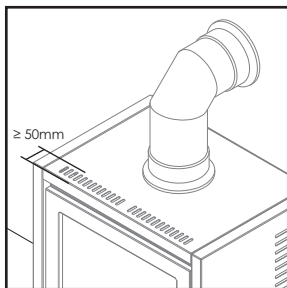

MONTAGE DU POËLE A BOIS (fourni séparément)

*Image à des fins d'illustration uniquement

1. Pour les produits avec pieds uniquement.
Pour les produits sans pieds, passez directement à l'étape 2.

REMARQUE : RETIRER LE BRÛLEUR AVANT DE COUCHER LE POËLE SUR LE DOS

Couchez le poêle sur le dos et retirez les 4 x pieds du poêle à l'aide d'un tournevis.

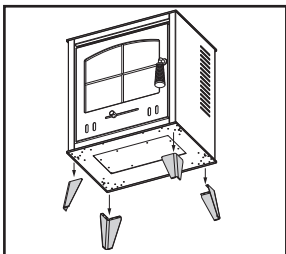

2. Positionner le poêle à bois à l'endroit souhaité.
Ensuite, soulevez avec précaution le poêle et placez-le sur le support à bûches.

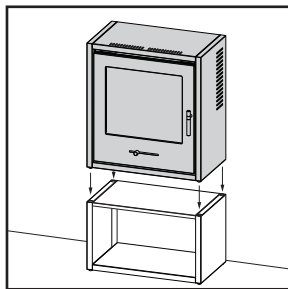
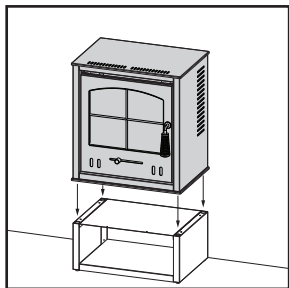
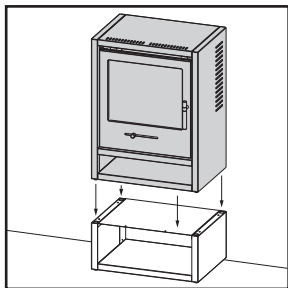

BIOETHANOL-KOCHER

Diese Anleitung ist in Verbindung mit dem Handbuch zu verwenden, das mit dem Ofen geliefert wird

*Die Bilder dienen nur zur Veranschaulichung

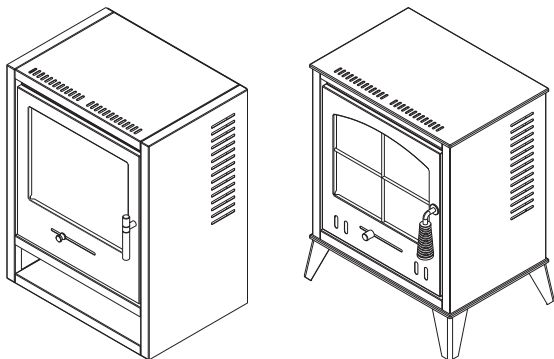

Diese Anleitung gilt für die folgenden Modelle:

OKO S1	OKO S2	OKO S3	BEF0014 (S1)	BEF0014 (S2)	BEF0018 (S3)
BEF0019	BEF0020	BEF0021	OKO S1-R	OKO S2-W	OKO S2-D
OKO S4	OKO S5	OKO S6			

**LEGEN SIE KEINE GEGENSTÄNDE in die Brennerkammer,
d.h. Keramikscheite/Kieselsteine usw.**

Dies beeinträchtigt den Luftstrom in der Kammer und entsteht eine unsichere und weniger kontrollierte Flamme.

Bitte lesen Sie zuerst die mit diesem Produkt mitgelieferte Gebrauch- und Pflegeanleitung.

www.firedupcorporation.com/manual

ABSTÄNDE VON DER WAND

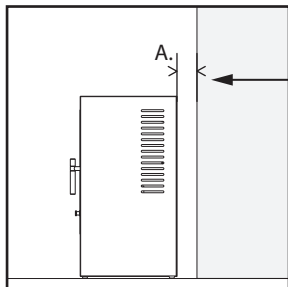

Abstand von A

- Marmor/Stein: > 5mm
- Holz (einschließlich MDF und MFC): > 10mm
- Tapete: > 100mm

ÖFFNEN DER TÜR

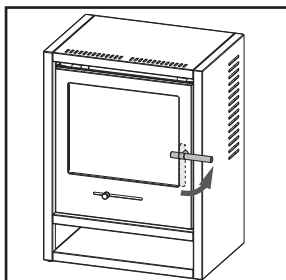

1. Um die Tür zu öffnen, drehen Sie den Griff gegen den Uhrzeigersinn in eine horizontale Position.

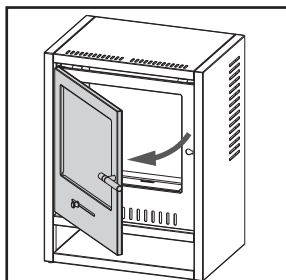

2. Ziehen Sie die Tür in dieser Position, um sie zu öffnen.

ACHTUNG

Lagern Sie keinen Brennstoff auf der Ablage unter dem Feuer.

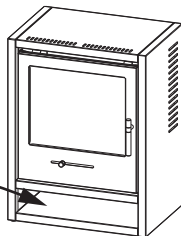

WICHTIG

EINBAU DES KAMINROHRS (falls zutreffend)

NUR MIT GERADEN ODER ABGEWINKELTEN ADAM-OFENROHREN KOMPATIBEL

Mitgelieferte Teile

2 x Metallplättchen

*Die Bilder dienen nur zur Veranschaulichung

1. Fügen Sie den Ofenrohreinsatz zu einem "X" zusammen und schieben Sie ihn in den Boden des Ofenrohrs.
2. Setzen Sie das Ofenrohr auf den Ofen und drücken Sie das Ofenrohr gegen die Wand/Rückwand.

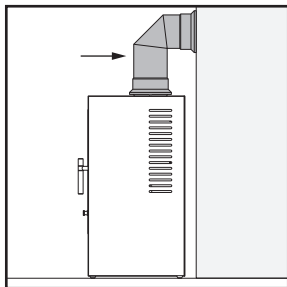
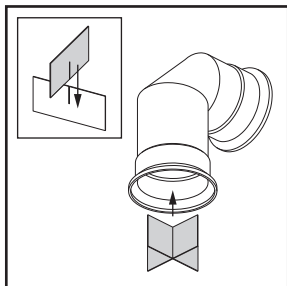

ACHTUNG: Stellen Sie KEINE Gegenstände innerhalb von 50 mm von der Vorderseite des Ofens auf, um sicherzustellen, dass die Lüftungsöffnungen auf der Oberseite des Ofens frei bleiben.

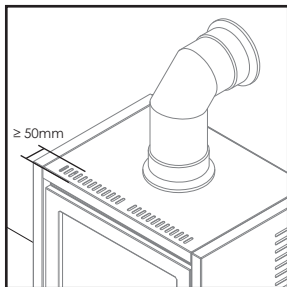

EINBAU DES LOG STORE (separat geliefert)

*Die Bilder dienen nur zur Veranschaulichung

1. **Nur für Produkte mit Füßen.**
Bei Produkten ohne Füße fahren Sie direkt mit Schritt 2 fort.

HINWEIS: ENTFERNEN SIE DEN BRENNER,
 BEVOR SIE DEN OFEN AUF DIE
 RÜCKSEITE LEGEN

Legen Sie den Kaminofen auf den Rücken
 und entfernen Sie die 4 Füße mit einem
 Schraubenzieher vom Kaminofen.

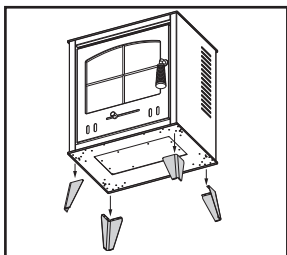

2. Positionieren Sie das Holzlager an der gewünschten Stelle.
 Heben Sie dann den Kaminofen vorsichtig an und setzen Sie ihn auf das Holzlager.

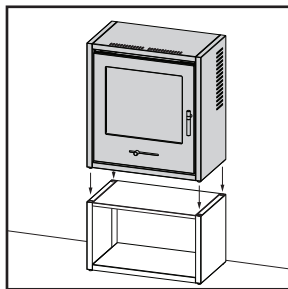
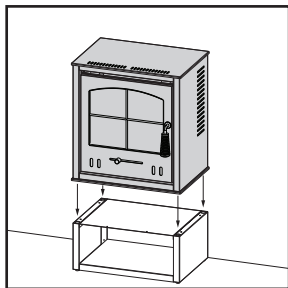
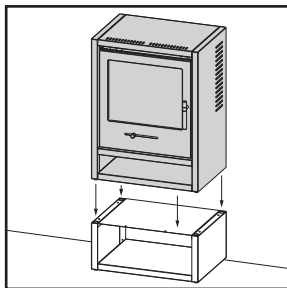

STUFA A BIOETANOLO

Questa guida deve essere utilizzata unitamente al manuale fornito insieme alla stufa

*Immagini solo a fini illustrativi

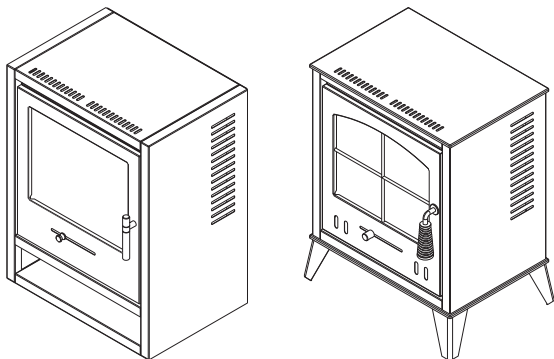

Questo manuale è adatto ai seguenti modelli:

OKO S1	OKO S2	OKO S3	BEF0014 (S1)	BEF0014 (S2)	BEF0018 (S3)
BEF0019	BEF0020	BEF0021	OKO S1-R	OKO S2-W	OKO S2-D
OKO S4	OKO S5	OKO S6			

NON POSIZIONARE NULLA all'interno della camera del bruciatore, cioè Tronchi di Ceramica/Ciottoli ecc.

Ciò influenzerà il flusso d'aria all'interno della camera e creerà una fiamma pericolosa e meno controllata.

Si prega di leggere prima il manuale per l'uso e la manutenzione fornito con questo prodotto.

www.firedupcorporation.com/manual

DISTANZE DALLA PARETE

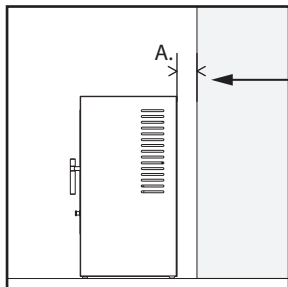

Distanza dal punto A

- Marmo/Pietra: > 5mm
- Legno (compresi MDF e MFC): > 10 mm
- Carta da parati: > 100 mm

APERTURA DELLA PORTA

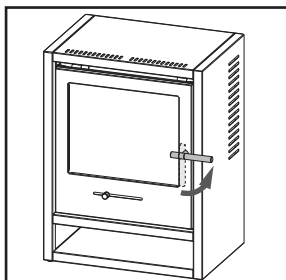

1. Per aprire la porta, ruotare la maniglia in senso antiorario in posizione orizzontale.

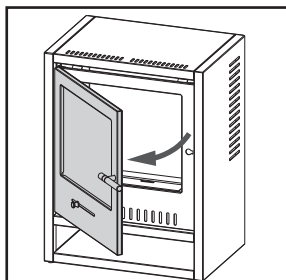

2. Una volta in posizione, tirare la porta per aprirla.

ATTENZIONE

Non conservare il combustibile sul ripiano al di sotto del fuoco.

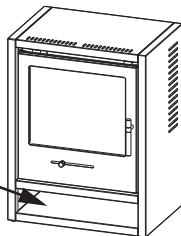

IMPORTANTE

MONTAGGIO DEL TUBO DELLA STUFA (se previsto)

COMPATIBILE SOLO CON TUBI DA STUFA ADAM DIRITTI O AD ANGOLO

Parti fornite

2 x Piastre Metalliche

*Immagini solo a fini illustrativi

1. Assemblare l'inserto del tubo della stufa in una "X" e spingerlo nella parte inferiore del tubo della stufa.
2. Posizionare il tubo della stufa al di sopra del prodotto e spingere il tubo contro la parete/pannello posteriore.

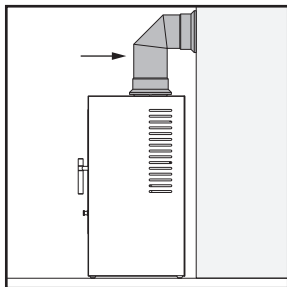
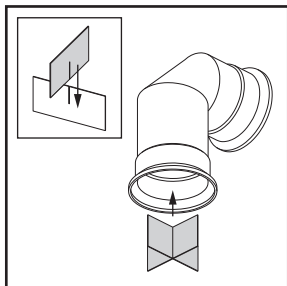

ATTENZIONE: NON posizionare nulla entro 50 mm dalla parte anteriore della stufa al fine di garantire che le prese d'aria presenti sulla parte superiore della stufa siano libere.

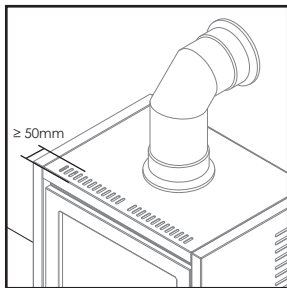

MONTAGGIO DEPOSITO LEGNA (fornito separatamente)

*Immagini solo a fini illustrativi

1. Solo per prodotti con piedini.
Per i prodotti senza piedini, andare direttamente allo Step 2.

NOTA: TOGLIERE IL BRUCIATORE PRIMA DI APPOGGIARE LA STUFA SULLA SOLA PARTE POSTERIORE

Appoggiare la stufa sul retro e rimuovere i 4 piedini dalla stufa usando un cacciavite.

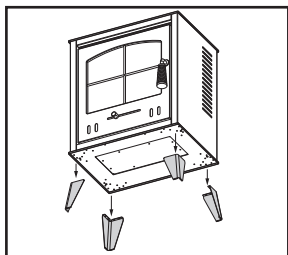

2. Posizionare il deposito nella posizione desiderata.
Quindi, sollevare con cautela la stufa e posizionarla sul deposito di legna.

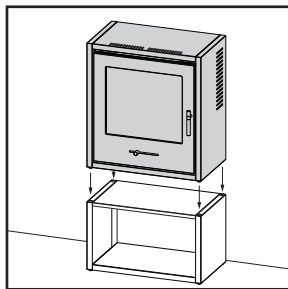
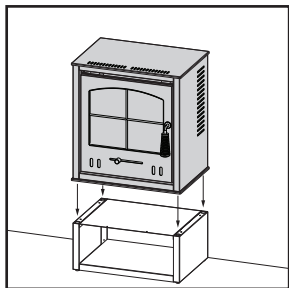
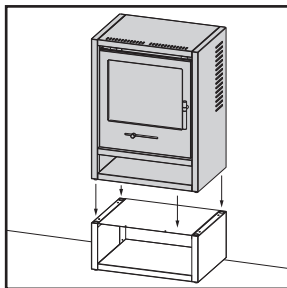

ESTUFA DE BIOETANOL

Este manual debe ser utilizado en conjunto con el manual suministrado con la estufa.

*Las imágenes son sólo para fines ilustrativos.

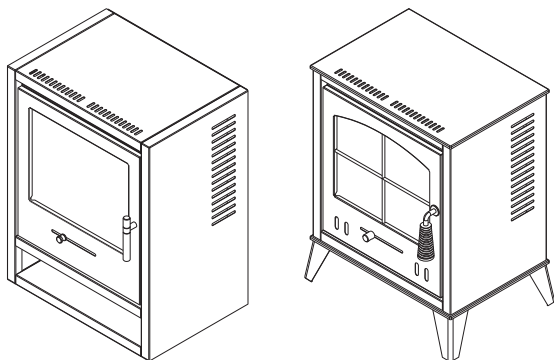

Es válido para los siguientes modelos:

OKO S1	OKO S2	OKO S3	BEF0014 (S1)	BEF0014 (S2)	BEF0018 (S3)
BEF0019	BEF0020	BEF0021	OKO S1-R	OKO S2-W	OKO S2-D
OKO S4	OKO S5	OKO S6			

NO COLOQUE NADA dentro de la cámara del quemador, es decir. Troncos de Cerámica/Guijarros etc.

Esto afectará el flujo de aire dentro de la cámara y creará una llama insegura y menos controlada.

Antes de comenzar, lea el manual de uso y cuidado proporcionado con este producto.

www.firedupcorporation.com/manual

DISTANCIAS DESDE LA PARED

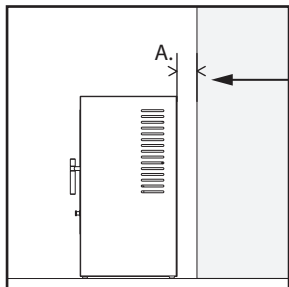

Distancia desde A.

- Mármol/Piedra: > 5 mm
- Madera (incluyendo MDF y MFC): > 10mm
- Papel pintado: > 100 mm

APERTURA DE LA PUERTA

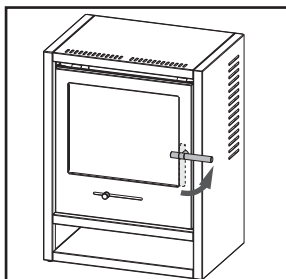

1. Para abrir la puerta, gire la manija en sentido antihorario hasta que quede en posición horizontal.

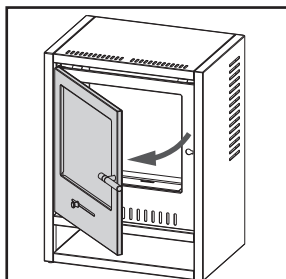

2. Una vez en posición, tire de la puerta para abrirla.

¡ATENCIÓN!

No almacene combustible en el estante situado debajo del fuego.

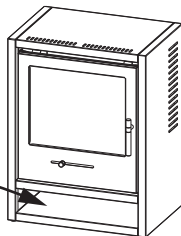

¡IMPORTANTE!

INSTALACIÓN DE LA TUBERÍA DE LA ESTUFA (si corresponde)

SOLO COMPATIBLE CON TUBOS DE ESTUFA ADAM RECTOS O EN ÁNGULO

Piezas suministradas

2 x Placas de Metal

*Las imágenes son sólo para fines ilustrativos.

1. Coloque el inserto de la tubería de la estufa en forma de "X" y empújelo hacia la parte inferior de la tubería de la estufa.

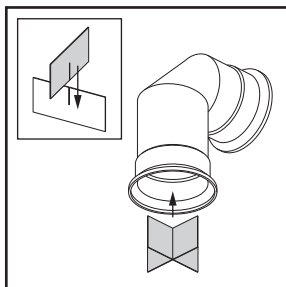

2. Coloque la tubería de la estufa en la parte superior de la estufa y presione la tubería de la estufa contra la pared o el panel posterior.

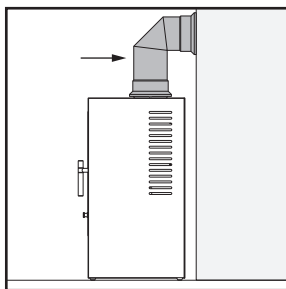

ATENCIÓN: Asegúrese de no colocar nada a menos de 50 mm de la parte delantera de la estufa para garantizar que las rejillas de ventilación en la parte superior de la estufa estén despejadas.

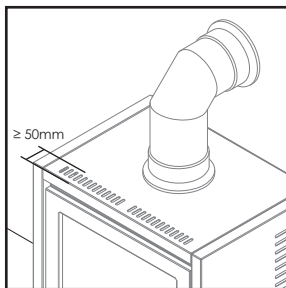

INSTALACIÓN DEL ALMACÉN DE LEÑA (suministrado por separado)

*Las imágenes son sólo para fines ilustrativos.

1. **Para productos con patas solamente.
Para productos sin patas, vaya
directamente al Paso 2.**

NOTA: ANTES DE COLOCAR LA ESTUFA EN
SU PARTE POSTERIOR, RETIRE
EL QUEMADOR.

Coloque la estufa boca abajo y use un
destornillador para quitar las 4 patas de la
estufa.

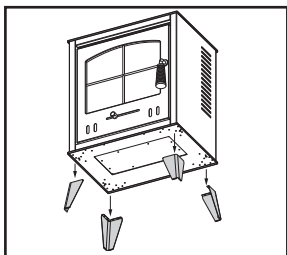

2. Coloque el almacén de leña en la ubicación deseada.
Luego, levante con cuidado la estufa y colóquela en el almacén de leña.

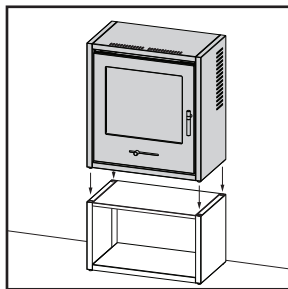
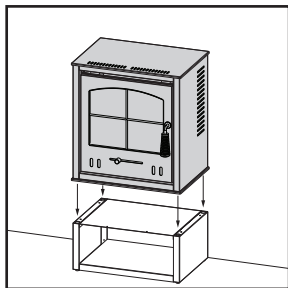
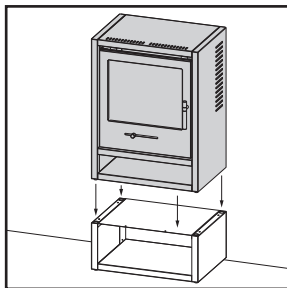

PIECYK NA BIO ETANOL

Niniejszy przewodnik należy stosować w połączeniu z instrukcją obsługi dołączoną do piecyka

*Ilustracje mają za zadanie zobrazować

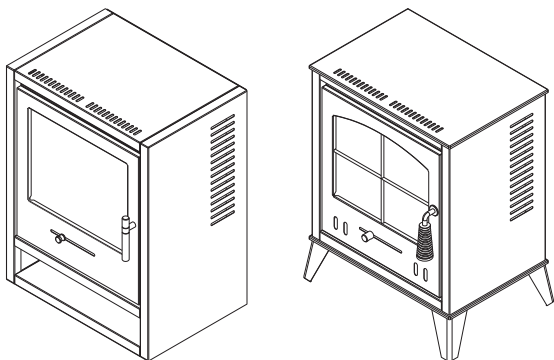

Niniejsza instrukcja dotyczy następujących modeli:

OKO S1	OKO S2	OKO S3	BEF0014 (S1)	BEF0014 (S2)	BEF0018 (S3)
BEF0019	BEF0020	BEF0021	OKO S1-R	OKO S2-W	OKO S2-D
OKO S4	OKO S5	OKO S6			

NIE WKŁADAĆ NICZEGO do komory palnika, tj. Bale Ceramiczne/Kamyki itp.

Wpłyne to na przepływ powietrza wewnątrz komory i spowoduje niebezpieczny i mniej kontrolowany płomień.

W pierwszej kolejności należy zapoznać się z instrukcją obsługi i konserwacji dołączoną do tego produktu.

www.firedupcorporation.com/manual

ODSTĘPY OD ŚCIAN

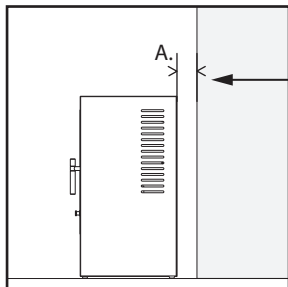

Odstęp od A

- Marmur/Kamień: > 5mm
- Drewno (włączając MDF i MFC): > 10mm
- Tapeta: > 100mm

OTWIERANIE DRZWI

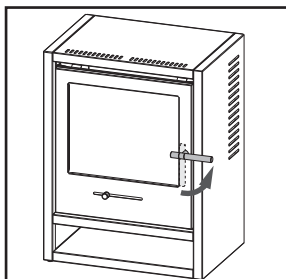

1. Aby otworzyć drzwi, przekręć uchwyt w lewo do pozycji poziomej.

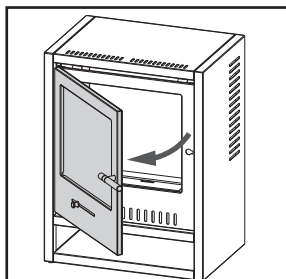

2. Po ustawieniu w odpowiednim położeniu pociągnij drzwiczki, aby je otworzyć.

UWAGA

Nie wolno przechowywać paliwa na półce pod paleniskiem.

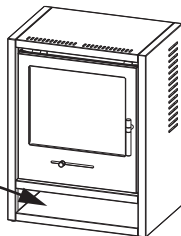

WAŻNE

UZUPEŁNIANIE RURY PIECYKA (jeśli to możliwe w tym modelu)

KOMPATYBILNY TYLKO Z PROSTYMI LUB KĄTOWYMI RURAMI PIECA ADAM

Części w zestawie

2 x Dwie blaszki

*Ilustracje mają za zadanie zobrazować

1. Złożyć wkład rury pieca w kształt litery "X" i wcisnąć w dolną część rury pieca.
2. Umieścić rurę pieca na górze pieca i docisnąć ją do ściany/ściany tylnej.

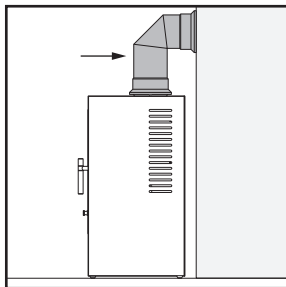
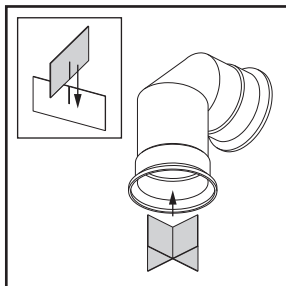

UWAGA: NIE WOLNO umieszczać żadnych przedmiotów w odległości mniejszej niż 50 mm od przedniej części kuchenki, aby zapewnić drożność otworów wentylacyjnych w górnej części kuchenki.

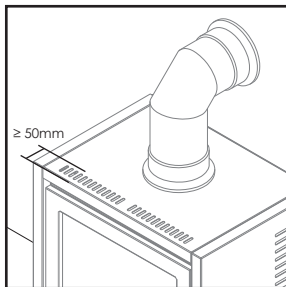

MONTAŻ SCHOWKA NA DREWNO (schowek dostarczany oddzielnie)

*Ilustracje mają za zadanie zobrazować

1. Tylko w przypadku produktów z nóżkami.
W przypadku produktów bez nóżek
przejdź od razu do kroku 2.

UWAGA: PRZED POŁOŻENIEM KUCHENKI
NA PLECACH NALEŻY WYJAĆ PALNIK

Położ kuchenkę na plecach i wyjmij 4 x
nóżki z kuchenki za pomocą śrubokręta.

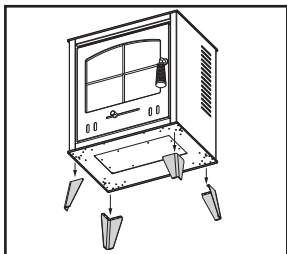

2. Umieścić skład polan w wybranym miejscu.
Następnie ostrożnie podnieść piec i umieść go na składowisku polan.

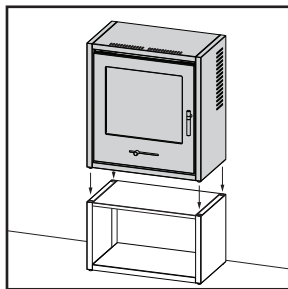
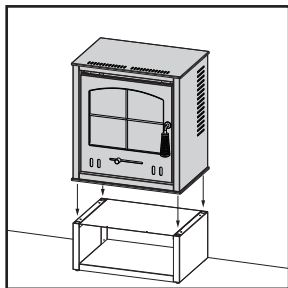
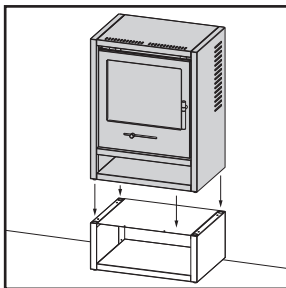

ARAGAZ BIO ETANOL

Acest ghid trebuie utilizat împreună cu manualul furnizat împreună cu aragazul.

*Imagini în scop ilustrativ

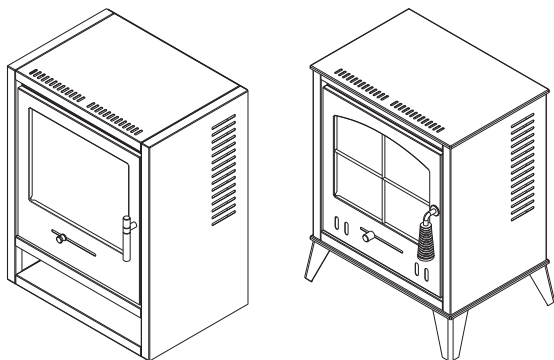

Acest manual este valabil pentru următoarele modele:

OKO S1	OKO S2	OKO S3	BEF0014 (S1)	BEF0014 (S2)	BEF0018 (S3)
BEF0019	BEF0020	BEF0021	OKO S1-R	OKO S2-W	OKO S2-D
OKO S4	OKO S5	OKO S6			

NU AȘEZĂȚI NIMIC în interiorul camerei arzătorului,
adică Busteni Ceramici/Pietricele etc.

Acest lucru va afecta fluxul de aer din interiorul camerei și va crea o
flacără nesigură și mai puțin controlată.

Vă rugăm să citiți mai întâi manualul de utilizare și îngrijire furnizat împreună
cu acest produs.

www.firedupcorporation.com/manual

DISTANȚE FAȚĂ DE PERETE

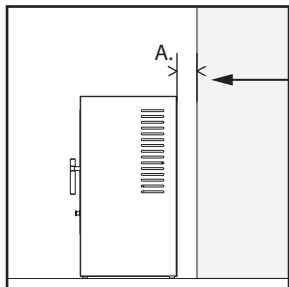

Distanța de la A

- Marmură/Piatră: > 5mm
- Lemn (inclusiv MDF și MFC): > 10mm
- Tapet: > 100mm

DESCHIDEREA UȘII

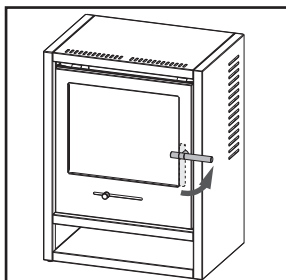

1. Pentru a deschide ușa, rotiți mânerul în sensul opus al acelor de ceasornic până în poziția orizontală.

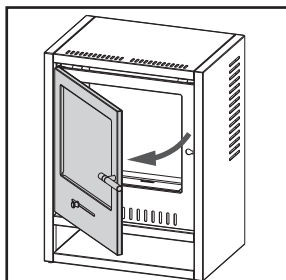

2. Odată ajuns în poziție, trageți ușa pentru a o deschide.

ATENȚIE

Nu depozitați combustibil pe raftul de sub foc.

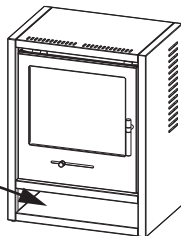

IMPORTANT**MONTAREA TUBULUI DE ARAGAZ (dacă este cazul)****COMPATIBIL NUMAI CU TUBURI DE ARAGAZ DREAPTE SAU ÎNCLINATE ADAM****Piese furnizate**

2 x Plăci metalice

*Imagini în scop ilustrativ

1. Asamblați insertul tubului de aragaz în formă de "X" și împingeți-l în partea de jos a tubului de aragaz.
2. Așezați tubul de aragaz deasupra aragazului și împingeți tubul de aragaz în perete/panoul din spate.

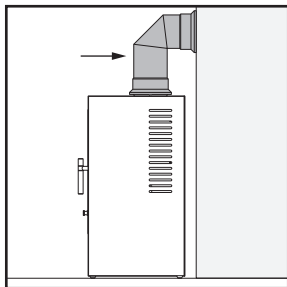
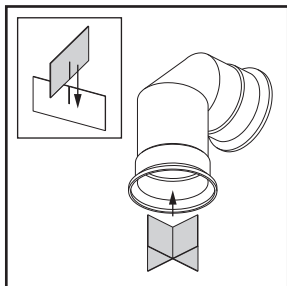

ATENȚIE: NU așezați nimic la mai puțin de 50 mm de partea din față a aragazului pentru a vă asigura că grilele de pe partea de sus a aragazului rămân libere.

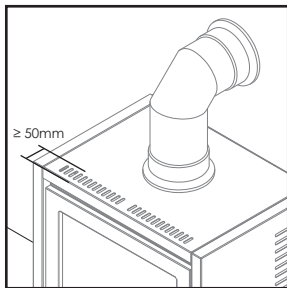

MONTAREA MAGAZIEI DE LEMNE (furnizată separat)

*Imagini în scop ilustrativ

- 1., **Destinată numai produselor cu picioare. Pentru produse fără picioare, treceți direct la Pasul 2.**

NOTĂ: SCOATEȚI ARZĂTORUL ÎNAINTE DE A AȘEZA ARAGAZUL PE SPATE

Așezați aragazul pe spate și scoateți cele 4 picioare ale aragazului folosind o șurubelniță.

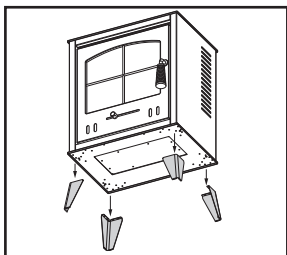

2. Poziționați magazia de lemne în locul dorit. Apoi, ridicați cu atenție aragazul și așezați-l pe magazie.

